



DISCOVER OUR SELECTION OF
UNIQUE AND AMAZING PRODUCTS.

vino bellezza

vino bellezza



in vino veritas

LEGEND



Ventilation System



Door with Mechanical Lock



UV Glass



Control Panel Screen



3 Year Warranty



Cooler/Cabinet Temperature



LED Lighting



Bottle Capacity



Number of Shelves

SIZES



PROPER TEMPERATURE RANGES



ALARMS

If you want your wine to stay fresh when you go to drink it, you have to store it at just the right – and constant – temperature. This is generally between +5°C and +18°C, depending on the kind. Therefore, your wine cooler/cabinet must be able to do that in a reliable manner. Vino Bellezza wine coolers are capable of offering just that – and using advanced alarm technology to boot. They alert you when you leave your cooler door ajar, and when the temperature inside is out of whack from what it ideally should be. All Vino Bellezza wine coolers keep all your wines as fresh as the day you first opened them – leaving the pleasure of sipping them to you.



UV PROTECTION GLASS

Exposure to sunlight or other bright forms of light speeds up the aging process of wine, which can spoil its taste. All Vino Bellezza wine coolers feature special UV protection glass doors. UV protection is enabled through tinted double-pane glasses with LOW-E coating. The double-pane glass is filled with argon gas which reflects almost all of the harmful UV rays back, protecting the wines from the adverse effects of light.



LED LIGHTING

Vino Bellezza wine coolers are equipped with LED lighting. The LED light spectrum does not give off UV rays. This makes it possible to illuminate the interior of the cooler uniformly for a long period of time without any harm to the wines. The LED lighting can be left on all the time, dimmed or turned off with a single switch.

NATURAL WOOD SHELVES

Wine is generally stored horizontally to keep the cork moist and prevent spoilage. Wine should be stored on hardwood shelves when stored for long periods, as metal shelves can lead to adverse effects such as condensation. All Vino Bellezza wine coolers come with five sturdy Russian pine wood shelves. These natural wood shelves are designed to perfectly accommodate Bordeaux bottles. The shelves are adjustable in height, allowing maximum capacity usage when bottles are fitted opposite each other. Additional wood shelves can be purchased as an accessory.



IDEAL TEMPERATURE IN ALL CONDITIONS

To preserve the quality of wine, storing it at the right temperature is a must. In general, the ideal storage temperature for all wines is between +5 °C and +14 °C. Another key requisite for storing wine is to keep the temperature as stable as possible. In particular, the serving temperature plays a key role in the taste and pleasure you get out of wine. Vino Bellezza wine coolers are equipped with a display panel that allows you to control the temperature. The temperature inside the cooler is adjusted electronically. The stainless steel accents are designed to ensure ideal storage temperature. LED lights generate very little and a negligible amount of heat, therefore allowing the lights to be left on for long durations without heating the bottles.



REDUCED VIBRATION

Vibration can also affect how fresh your wine stays over time. Failure to prevent it can cause sediment to form within your bottles, ultimately making your wine to taste and even look strange. Vibration also causes the wine's tannins to collide, in turn undesirably accelerating the otherwise natural aging process. The more you protect your wine from vibration, the longer it'll last and taste better it'll taste.

All Vino Bellezza wine coolers feature special vibration-absorbing rubber wedges attached to the cooling cycle compressor. Moreover, they also feature static condensers that cool the gas inside, therefore preventing the need for a conventional fan motor - another cause of vibration. This kills two birds with one stone: say goodbye to unwanted shaking, and hello to saving energy.

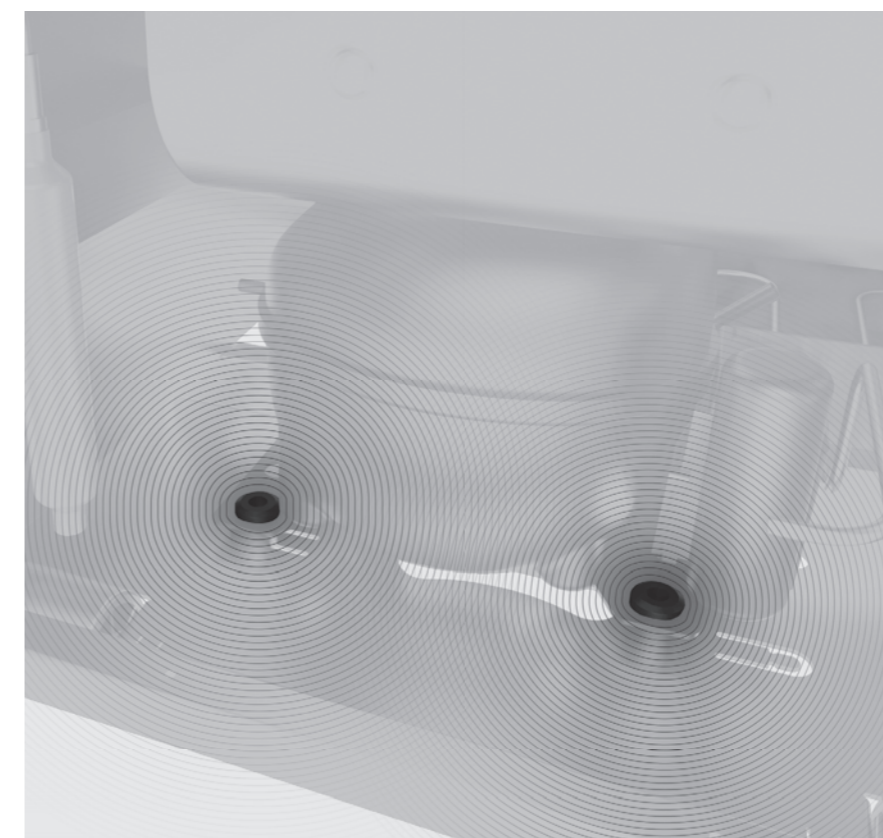

14

DIGITAL DISPLAY



Power Button



Light Control



Temperature Down



Temperature Up



Vino Bellezza means 'beautiful wine' in Italian. What makes wine beautiful?

While all wine lovers surely have a different answer to this question, everyone will agree that once wine is produced, it needs to be stored under specific conditions to preserve its beauty and quality.

Wine is considered to be a living drink as it continues to mature in the barrel and, subsequently, in the bottle. That is why wine needs to be stored in an undisturbed place with a constant temperature and ideal humidity without any direct exposure to sunlight or bright lights.

Not all wine lovers have access to such an environment - one that only a cellar can provide naturally. That's where Vino Bellezza wine coolers come to the rescue.

Vino Bellezza's story began in 2016 when Öztaş Iron & Steel Co. entered the commercial cooler market, building on its ever-growing refrigeration know-how dating back to 1980. Vino Bellezza wine coolers are the end product of its ongoing R&D efforts since then.

Offering a range of benefits, Vino Bellezza wine coolers are available in four different lines. Vino Bellezza wine coolers are set to become the new choice of wine lovers thanks to their high performance, easy-to-use features, ergonomic and sleek design and, most importantly, accessible prices. Whether for your kitchen, living room, office or boat, we've got a Vino Bellezza to suit all needs.





BUILT-IN SERIES

Built-In Wine Coolers: Where Style Meets Functionality!

Our built-in wine coolers offer the perfect solution for wine enthusiasts. With their modern design, these elegant coolers not only add sophistication to your kitchens but also preserve your wine collections in the best possible way. Maintain optimum temperature and humidity control to preserve the flavor of your wines at all times. Elevate your wine experience with our built-in wine coolers!



V 45

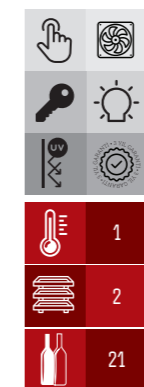

V45 is a modern built-in wine cooler that complements the elegance and comfort of your home. With a capacity of 21 bottles, it provides an ideal solution to store and display your select wines at perfect temperatures. Its sleek design adds sophistication to your kitchen or indoor space.

1

2

21



Hornbeam Shelf

Internal Dimensions
W. 492 - D. 330 - H. 369 mm
External Dimensions
W. 569 - D. 556 - H. 463 mm
Net Weight : - kg
Gross Weight : - kg

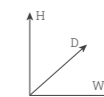



V 6 0



Serving as a perfect built-in solution to preserve and showcase your wine collection, V60 boasts a stylish and functional design. Its digital display and precise temperature control ensure each bottle is stored under optimal conditions. Furthermore, its quiet operation maintains the tranquility of your home.



Hornbeam Shelf

Internal Dimensions
W. 492 - D. 330 - H. 509 mm
External Dimensions
W. 596 - D. 556 - H. 607 mm
Net Weight : - kg
Gross Weight : - kg

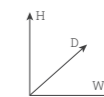



V72

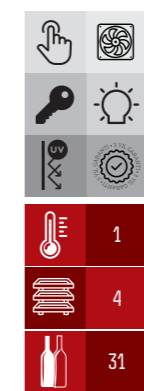

- 1
- 4
- 31

V72 is a high-quality built-in wine cooler designed to meet the needs of wine enthusiasts. With a capacity of 31 bottles, it allows for organizing and maintaining various wines at desired temperatures. Its aesthetic and ergonomic design blends seamlessly into any interior and beautifully showcases your wine collection.



Internal Dimensions
 W. 492 - D. 330 - H. 643 mm
External Dimensions
 W. 596 - D. 556 - H. 730 mm
 Net Weight : - kg
 Gross Weight : - kg

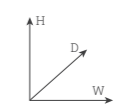



V 8 0

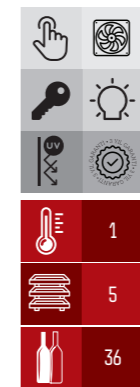

The V80 is an exquisite built-in wine cabinet that adds a touch of sophistication to any modern home. With a storage capacity of up to 36 bottles, it offers the perfect solution for preserving and presenting your wine collection at its best. Its sleek and contemporary design seamlessly integrates into your kitchen or living space, elevating the ambiance with its presence.



Internal Dimensions
W. 492 - D. 330 - H. 789 mm
External Dimensions
W. 596 - D. 556 - H. 877,5 mm
Net Weight : - kg
Gross Weight : - kg

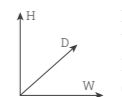

BUILT-IN

TECHNICAL SPECIFICATIONS



	V45	V60	V72	V80
Gross Volume (Lt.)	154	201	242	290
Net Volume (Lt.)	60	82	104	128
Internal Dimensions (w*d*h) (mm)	492*330*369	492*330*509	492*330*643	492*330*789
External Dimensions (w*d*h) (mm)	596*556*463	596*556*607	596*556*730	596*556*875.5
Packaged Dimensions (w*d*h) (mm)	690*750*734	690*750*877	690*750*1010	690*750*1157
Net Weight (kg)				
Gross Weight (kg)				
Footprint (m ²)	0.331	0.331	0.331	0.331
Bottle Capacity	21	26	31	36
20" Container Loading Capacity	72	54	51	48
40" Container Loading Capacity	153	117	105	102
40" High Container Loading Capacity	153	153	105	102
13,6 Meter Truck Loading Capacity	171	171	117	114
Cooling Gas	+5 / +18 °C	+5 / +18 °C	+5 / +18 °C	+5 / +18 °C
Climate Class	R600a	R600a	R600a	R600a
Energy Class	B	B	B	B
Supply Voltage	220-240V /50Hz	220-240V /50Hz	220-240V /50Hz	220-240V /50Hz
LED Lighting	Yes	Yes	Yes	Yes
4 Wheels	No	No	No	No
2 Adjustable Feet	4 Adjustable Feet	4 Adjustable Feet	4 Adjustable Feet	4 Adjustable Feet
Door Type	Frameless	Frameless	Frameless	Frameless

vino bellezza

vino bellezza





FACTORY

T +90 236 213 12 12 (pbx)
F +90 236 213 12 08
M.O.S.B 4. Kısım Ahmet
Nazif Zorlu Bulvarı No:32
Manisa/TÜRKİYE

ISTANBUL OFFICE

T +90 212 272 15 95
Metrocity AVM
Büyükdere Caddesi
No:171 - BB107 Şişli,
Istanbul/TÜRKİYE

www.vinobellezza.com
info@vinobellezza.com
©    vinobellezza